

Job Name:

System Reference:

Date:

Indoor Unit:

PEAD-A18AA7

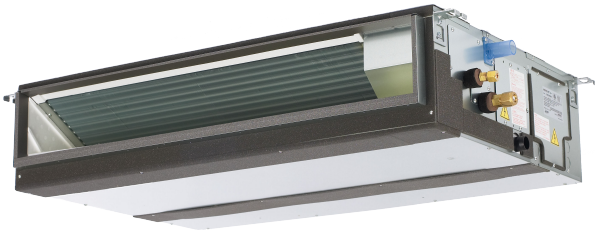

Outdoor Unit:

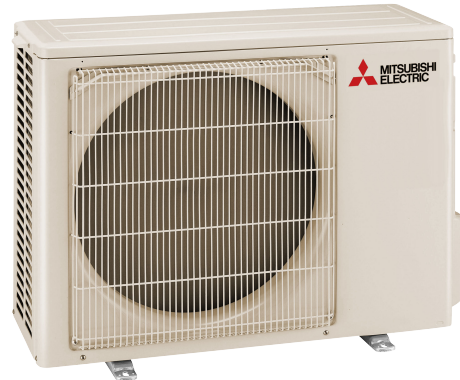
 PUZ-A18NKA7 PUZ-A18NKA7-BS**INDOOR UNIT FEATURES**

- Unobtrusive ceiling-concealed design for short-run ductwork.
- Wide ranging external static pressure
- Built-in condensate lift mechanism
- Auto fan speed mode
- Optional FB Series filter boxes for easy access and service
- Ideal for residential homes, retail shopping centers, larger classrooms, office complexes, conference ballrooms, fitness centers, and more

OUTDOOR UNIT FEATURES

- Variable speed INVERTER-driven compressor
- Suction accumulator pre-charged with refrigerant volume for piping length up to 100 ft (70 ft. for A12/18/24/30)
- 24-hour continuous operation (cooling mode)
- High pressure protection
- Fast restart due to bypass valve make it ideal for equipment cooling applications, such as data centers
- Superior energy and operational efficiency

SPECIFICATIONS: PEAD-A18AA7 & PUZ-A18NKA7(-BS)

Model number	Indoor unit		PEAD-A18AA7
	Outdoor unit		PUZ-A18NKA7
			PUZ-A18NKA7-BS
Cooling*1	Maximum Capacity	Btu/h	18,000
	Rated Capacity	Btu/h	18,000
	Minimum Capacity	Btu/h	8,000
	Maximum Power Input	W	1,660
	Rated Power Input	W	1,660
	Moisture Removal	Pints/h	3.70
	Sensible Heat Factor		0.77
	Power factor	%	91.4
Heating at 47° F*2	Maximum Capacity	Btu/h	22,000
	Rated Capacity	Btu/h	19,000
	Minimum Capacity	Btu/h	7,900
	Maximum Power Input	W	1,750
	Rated Power Input	W	1,400
	Power factor	%	92.0
Heating at 17° F*3	Maximum Capacity	Btu/h	13,500
	Rated Capacity	Btu/h	11,000
	Maximum Power Input	W	1,440
	Rated Power Input	W	1,350
Efficiency	SEER		19.9
	EER *1		10.8
	HSPF (IV)		10.2
	COP at 47° F *2		3.97
	COP at 17° F *3		2.38
Electrical	Voltage, Phase, Frequency		208 / 230V, 1-phase, 60 Hz
	Guaranteed Voltage Range	V AC	187 - 253
	Voltage: Indoor - Outdoor, S1-S2	V AC	208V / 230
	Voltage: Indoor - Outdoor, S2-S3	V DC	24
	Voltage: Indoor - Remote controller	V DC	12
	Recommended Fuse/Breaker Size	A	15
	Recommended Wire Size (Indoor - Outdoor)	AWG	14
Indoor unit	MCA	A	1.69
	MOCP	A	15
	Fan Motor Full Load Amperage	A	1.35

SPECIFICATIONS: PEAD-A18AA7 & PUZ-A18NKA7(-BS)

Model number	Indoor unit		PEAD-A18AA7
	Outdoor unit		PUZ-A18NKA7
			PUZ-A18NKA7-BS
	Fan Motor Output	W	85
	Airflow Rate, Dry	CFM	424-512-600
	Airflow Rate, Wet	CFM	384-472-560
	External Static Pressure	in.WG	0.14-0.20-0.28-0.40-0.60
	Sound Pressure Level	dB(A)	30-33-37
	Drain Pipe Size	In. (mm)	1-1/4 (32)
	Condensate Lift Mechanism, Max. Distance	Ft. (m)	27-9/16 (700)
	Heat Exchanger Type		Plate fin coil
	External finish color		Galvanized
	Unit Dimensions // Grille Dimensions	W: In. (mm)	35-7/16 (900)
		D: In. (mm)	28-7/8 (732)
		H: In. (mm)	9-7/8 (250)
	Package Dimensions // Grille Dimensions	W: In.	45-5/16
		D: In.	34-11/16
		H: In.	13-7/16
	Unit Weight	Lbs. (kg)	62 (28)
	Package Weight	Lbs.	71
Indoor unit operating temperature range	Cooling Intake Air Temp (Maximum / Minimum)	°F	90 DB, 73 WB / 66 DB, 59 WB
	Heating Intake Air Temp (Maximum / Minimum)	°F	82 DB / 50 DB
Outdoor unit	MCA	A	11
	MOCP	A	28
	Fan Motor Full Load Amperage	A	0.5
	Fan Motor Output	W	46
	Airflow Rate	CFM	1,590
	Refrigerant Control		Electronic Expansion Valve
	Defrost Method		Reverse Cycle
	Heat Exchanger Type		Cross fin
	Sound Pressure Level, Cooling*1	dB(A)	44
	Sound Pressure Level, Heating*2	dB(A)	46
	Compressor Type		INVERTER-driven twin rotary
	Compressor Model		SNB130FNCM2
	Compressor Rated Load Amps	A	7

SPECIFICATIONS: PEAD-A18AA7 & PUZ-A18NKA7(-BS)

Model number	Indoor unit		PEAD-A18AA7	
	Outdoor unit		PUZ-A18NKA7	
			PUZ-A18NKA7-BS	
	Compressor Locked Rotor Amps	A	12	
	Compressor Oil Type // Charge	oz.	FV50S // 16	
	External finish color	Ivory Munsell 3Y 7.8/1.1		
	Base pan heater	n/a		
	Unit Dimensions	W: In. (mm)	31-13/16 + 7/16 (809+62)	
		D: In. (mm)	11-3/16 (300)	
		H: In. (mm)	24-13/16 (630)	
	Package Dimensions	W: In.	37-1/16	
		D: In.	16-3/16	
		H: In.	27-7/16	
	Unit Weight	Lbs.	100 (45)	
	Package Weight	Lbs.	104 (47)	
Outdoor unit operating temperature range	Cooling *5 Intake Air Temp (Maximum / Minimum)	°F	115 DB / 0* DB	
	Heating Intake Air Temp (Maximum / Minimum)	°F	70 DB, 59 WB / 12 DB, 10 WB	
	Thermal Lock-out / Re-start Temperatures**	°F	8 / 12 DB	
Refrigerant	Type	R410A		
	Charge	Lbs, oz	4 lbs, 14 oz	
Piping	Gas Pipe Size O.D. (Flared)	In.(mm)	1/2 (12.7)	
	Liquid Pipe Size O.D. (Flared)	In.(mm)	1/4 (6.35)	
	Maximum Piping Length	Ft. (m)	100 (30)	
	Maximum Height Difference	Ft. (m)	100 (30)	
	Maximum Number of Bends	15		

AHRI Rated Conditions	*1 Cooling (Indoor // Outdoor)	°F	80°F DB, 67°F WB // 95°F DB, 75°F WB
	*2 Heating at 47°F (Indoor // Outdoor)	°F	70°F DB, 60°F WB // 47°F DB, 43°F WB
	*3 Heating at 17°F (Indoor // Outdoor)	°F	70°F DB, 60°F WB // 17°F DB, 15°F WB
Conditions	*4 Heating at 5°F (Indoor // Outdoor)	°F	70°F DB, 60°F WB // -4°F DB, -5°F WB

Notes

*Wind baffles required to operate below 23°F DB in cooling mode. PUZ with wind baffle: 0°F - 115°F.

**System cuts out in heating mode to avoid thermistor error and automatically restarts at these temperatures

SPECIFICATIONS: PEAD-A18AA7 & PUZ-A18NKA7(-BS)

SEACOAST PROTECTION

External Outer Panel: Phosphate coating + Acrylic-Enamel coating

Fan Motor Support: Epoxy resin coating (at edge face)

Separator Assembly; Valve Bed: Epoxy resin coating (at edge face)

“Blue Fin” treatment is an anti-corrosion treatment that is applied to the condenser coil to protect it against airborne contaminants.

Notes:

ACCESSORIES: PEAD-A18AA7 & PUZ-A18NKA7(-BS)

PEAD-A18AA7	
Filter Box with Filters (MERV 13)	<input type="checkbox"/> FBM2-2
3-Pole Disconnect Switch (30A/600V/UL) [fits 2" X 4" utility box]	<input type="checkbox"/> TAZ-MS303
Drain Pan Level Sensor (Control for indoor unit shut off to prevent drain pan overflow)	<input type="checkbox"/> DPLS2
Advanced Blue Diamond Mini-Condensation pump w/ Reservoir & Sensor (110V)	<input type="checkbox"/> X87-711 - 110
Advanced Blue Diamond Mini-Condensation pump w/ Reservoir & Sensor (208/230V)	<input type="checkbox"/> X87-721 - 208/230
Extension Cord for Blue Diamond Pump	<input type="checkbox"/> C13-103
MegaBlue Blue Diamond Condensate Pump (110-230V)	<input type="checkbox"/> X87-835
Remote Sensor (extensible)	<input type="checkbox"/> PAC-SE41TS-E
Connector Cable for Remote Display	<input type="checkbox"/> PAC-SA88HA-EP
	<input type="checkbox"/> PAC-725AD-E (10pcs)
Connector for CN32 (remote ON/OFF)	<input type="checkbox"/> PAC-SE55RA-E
Connector for CN24 (Back up heating)	<input type="checkbox"/> PAC-SE56RA-E
Connector for CN30 (LLC)	<input type="checkbox"/> PAC-SE57RA-E
Remote Operation Adapter (with wire terminals for remote ON/OFF and operation status/error)	<input type="checkbox"/> PAC-SF40RM-E ^{*1}
External fan / Heater control relay adapter	<input type="checkbox"/> CN24RELAY-KIT-CM3
Backlit, wall-mounted, wireless	<input type="checkbox"/> MHK1
Wireless adapter	<input type="checkbox"/> PAC-USWHS002-WF-1
BACnet® and Modbus Interface	<input type="checkbox"/> PAC-UKPRC001-CN-1
Wall-mounted, Wired	<input type="checkbox"/> PAC-YT53CRAU-J
Wired remote controller	<input type="checkbox"/> PAR-32MAA-J
T-STAT Interface	<input type="checkbox"/> PAC-US444CN-1
Wired remote controller	<input type="checkbox"/> PAR-32MAA
Signal Receiver	<input type="checkbox"/> PAR-SA9CA-E
Wireless Remote Controller	<input type="checkbox"/> PAR-FL32MA-E
Wireless Signal Receiver	<input type="checkbox"/> PAR-FA32MA-E
Wire for Remote ON/OFF with CN32 connector	<input type="checkbox"/> PAC-715AD
Lockdown Bracket for wireless, hand-held, remote controllers	<input type="checkbox"/> RCMKP1CB

^{*1} Unable to use with wireless remote controller

PUZ-A18NKA7(-BS)	
Air Outlet Guide	<input type="checkbox"/> PAC-SJ07SG-E
Front Wind Baffle	<input type="checkbox"/> WB-PA
Drain socket	<input type="checkbox"/> PAC-SJ08DS-E
Centralized Drain Pan	<input type="checkbox"/> PAC-SG63DP-E
M-NET Converter	<input type="checkbox"/> PAC-SJ19MA-E

ACCESSORIES: PEAD-A18AA7 & PUZ-A18NKA7(-BS)

PUZ-A18NKA7(-BS)	
Control/Service Tool	<input type="checkbox"/> PAC-SK52ST
Wall mounting bracket (powder-coated steel)	<input type="checkbox"/> QCWB2000M-1
Wall mounting bracket (316 Series Stainless Steel)	<input type="checkbox"/> QCWBSS
M-NET control adapter for Building Management System	<input type="checkbox"/> PAC-SF83MA-E
Outdoor Unit Mounting Pad 16" x 36" x 3"	<input type="checkbox"/> ULTRILITE1
Outdoor Unit 3-1/4 inch Mounting Base - Pair (Plastic)	<input type="checkbox"/> DSD-400N
MiniSplit Mounting Stand-Single Fan models - 12"	<input type="checkbox"/> QSMS1201M
MiniSplit Mounting Stand-Single Fan models - 18"	<input type="checkbox"/> QSMS1801M
MiniSplit Mounting Stand-Single Fan models - 24"	<input type="checkbox"/> QSMS2401M
1/4 x 1/2 x 15' / 1/2" Lineset (Twin-Tube Insulation)	<input type="checkbox"/> MLS141212T-15
1/4 x 1/2 x 30' / 1/2" Lineset (Twin-Tube Insulation)	<input type="checkbox"/> MLS141212T-30
1/4 x 1/2 x 50' / 1/2" Lineset (Twin-Tube Insulation)	<input type="checkbox"/> MLS141212T-50
1/4 x 1/2 x 65' / 1/2" Lineset (Twin-Tube Insulation)	<input type="checkbox"/> MLS141212T-65
1/4 x 1/2 x 100' / 1/2" Lineset (Twin-Tube Insulation)	<input type="checkbox"/> MLS141212T-100

DIMENSIONS: PEAD-A18AA7 & PUZ-A18NKA7 (-BS)

PEAD-A18AA7

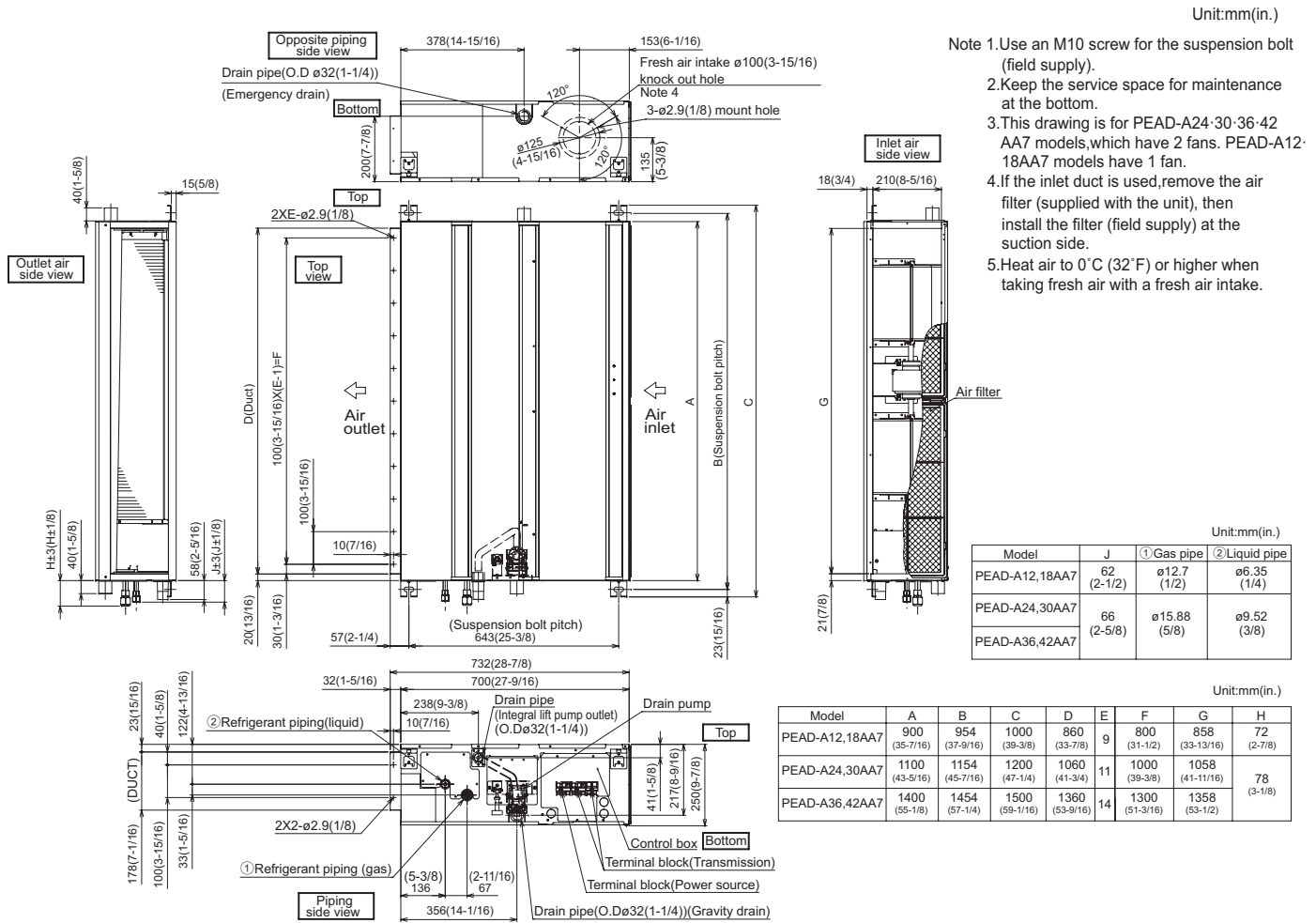

DIMENSIONS: PEAD-A18AA7 & PUZ-A18NKA7 (-BS)

PUZ-A18NKA7(-BS)

Unit: mm<in>

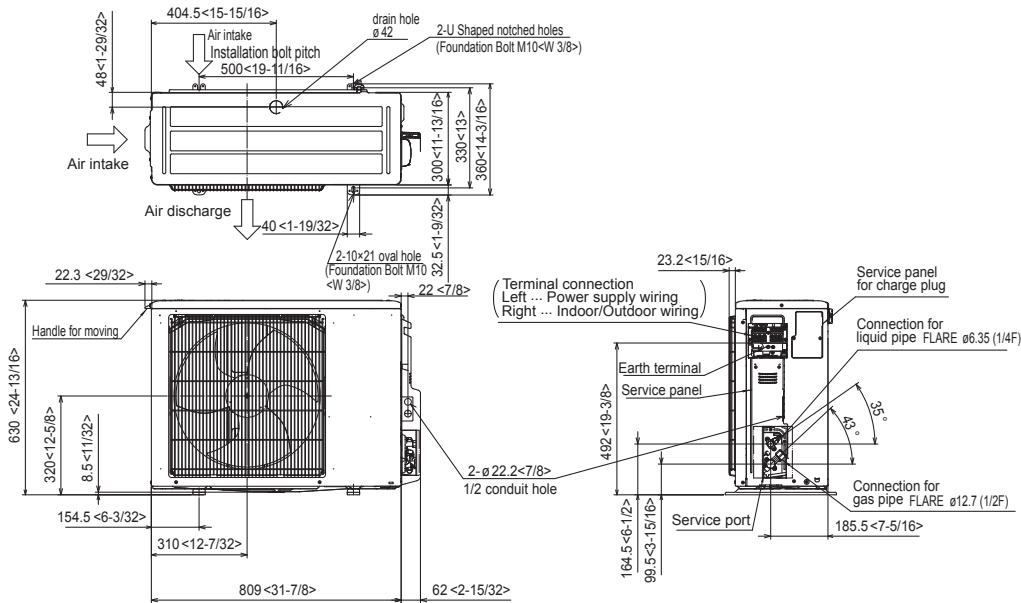

Free space around the outdoor unit (basic example)

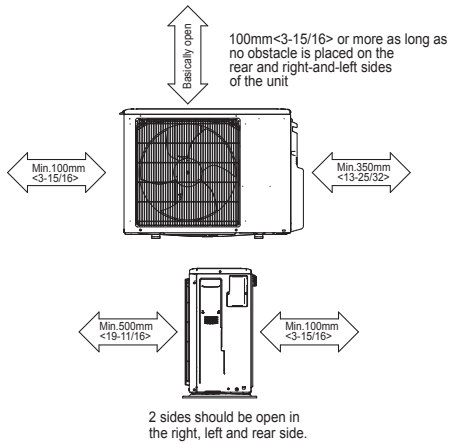

FOUNDATION BOLTS

Please secure the unit firmly with 4 foundation (M10<W3/8>) bolts. (Bolts, washers and nut must be purchased locally).

<Foundation bolt height>

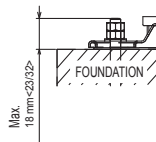

PIPING-WIRING DIRECTION

Piping and wiring connection can be made from the rear direction only.

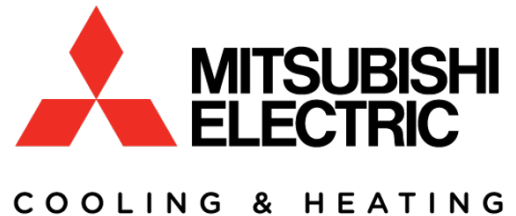

1340 Satellite Boulevard, Suwanee, GA 30024
 Toll Free: 800-433-4822 www.mehvac.com

FORM# PEAD-A18AA7 / PUZ-A18NKA7(-BS) - 201701



Specifications are subject to change without notice.

Copyright © 2017 Mitsubishi Electric US, Inc.